



FUTURE
MOBILITY HEALTHCARE
DIVISION OF ABF MFG GROUP INC.
WWW.FUTUREMOBILITY.CA



TEL: 905-671-1661
FAX: 905-671-3377

Account Information: Account #: _____ Business Name: _____ Ship to Address: _____ Fax: _____ Contact: _____ TAG FOR: _____	Order Date: _____ P.O.#: _____ Phone: _____ City: _____ Province: _____ Postal Code: _____
--	--

- ① FRAME TYPE**
- Stellato Folding Chair WMA2FM005 102 \$1,350
- ② FRAME FINISH**
- Black 102C01 No Charge
- Silver 102C02 No Charge
- Custom Colours**
- Blue 102C03 \$150
- Green 102C04 \$150
- Orange 102C05 \$150
- Purple 102C06 \$150
- Red 102C07 \$150
- Yellow 102C08 \$150
- Custom Colour 102C17 \$150

Standard Chair Includes:

Lightweight Folding Frame
 Elliptical Heavy duty Cross brace Tubing
 Seat Width (14"-20")
 Seat Depth (15"-20")
 Seat-To-Floor Height (13.25"-19.0")
 Rear Wheel Options (20", 22" or 24")
 Handrim Options (Stainless Steel)
 Caster Options (4", 5", 6", 7" or 8")
 Nylon Seat Upholstery
 Slip on Back Upholstery
 Angle Adjustable Push Canes
 Aluminum Flip-Up Footplate
 Heel Loops
 Wheel Locks (Push or Pull to Lock)
 Side Storage Pocket
 Choice of Two Colors (Black or Silver)

③ SIDE FRAME MATRIX

WIDTH	SEAT DEPTH					
	15	16	17	18	19	20
14	SMALL	SMALL	SMALL	SMALL		
15	SMALL	SMALL	SMALL	SMALL		
16	SMALL	SMALL	SMALL	SM/ LG	LARGE	LARGE
17	SMALL	SMALL	SMALL	SM/ LG	LARGE	LARGE
18	SMALL	SMALL	SMALL	SM/ LG	LARGE	LARGE
19				LARGE	LARGE	LARGE
20				LARGE	LARGE	LARGE

- ④ SEAT WIDTH**
- 14" Seat Width 102SW14 No Charge
- 15" Seat Width 102SW15 \$125
- 16" Seat Width 102SW16 No Charge
- 17" Seat Width 102SW17 No Charge
- 18" Seat Width 102SW18 No Charge
- 19" Seat Width 102SW19 \$125
- 20" Seat Width 102SW20 No Charge
- 22" Seat Width 102SW22 \$475

- ⑤ SEAT DEPTH**
- 15" Seat Depth 102SD15 \$125
- 16" Seat Depth 102SD16 No Charge
- 17" Seat Depth 102SD17 \$125
- 18" Seat Depth 102SD18 No Charge
- 19" Seat Depth 102SD19 \$125
- 20" Seat Depth 102SD20 No Charge



FOOTNOTES:

A. Seat angle is set at 3 degrees. See service manual for details

B. For 18" Seat Depth (16"-18"W) both large and small frame available

STELLATO FRONT STF HEIGHT AVAILABILITY										
SMALL FRAME										
REAR WHEEL		4" CASTER								
20"	13.25"									
REAR WHEEL		5" CASTER								
20"		14.5"	15"	15.5"						
22"				16"						
REAR WHEEL		6" CASTER								
22"				16"	16.5"					
REAR WHEEL		7" CASTER								
22"					16.5"	17"				
24"										
REAR WHEEL		8" CASTER								
24"						17.5"	18"			
LARGE FRAME										
REAR WHEEL		5" CASTER								
20"				15.5"						
22"					16"	16.5"				
REAR WHEEL		6" CASTER								
22"					16.5"					
24"					16.5"	17"	17.5"	18"		
REAR WHEEL		7" CASTER								
22"						17"				
24"						17.5"	18"	18.5"		
REAR WHEEL		8" CASTER								
24"								18.5"	19"	

⑥ SEAT-TO-FLOOR HEIGHT - small frame

- 13.25" Seat to Floor (20" Wheels and 4" Casters) 102STF01 No Charge
- 14.5" Seat to Floor (20" rear and 5" casters) 102STF02 No Charge
- 15" Seat to Floor (20" Wheels and 5" Casters) 102STF03 No Charge
- 15.5" Seat to Floor (20" Wheels and 5" Casters) 102STF04 No Charge
- 16" Seat to Floor (22" Wheels and 5" Casters) 102STF05 No Charge
- 16" Seat to Floor (22" Wheels and 6" Casters) 102STF06 No Charge
- 16.5" Seat to Floor (22" Wheels and 6" Casters) 102STF07 No Charge
- 16.5" Seat to Floor (22" Wheels and 7" Casters) 102STF08 No Charge
- 17" Seat to Floor (22" Wheels and 7" Casters) 102STF09 No Charge
- 17.5" Seat to Floor (24" Wheels and 8" Casters) 102STF10 No Charge
- 18" Seat to Floor (24" Wheels and 8" Casters) 102STF11 No Charge

⑦ SEAT-TO-FLOOR HEIGHT - large frame

- 14.5" Seat to Floor (20" Wheels and 4" Casters) 102STF25 No Charge
- 15.5" Seat to Floor (20" Wheels and 5" Casters) 102STF12 No Charge
- 16" Seat to Floor (22" Wheels and 5" Casters) 102STF13 No Charge
- 16.5" Seat to Floor (22" Wheels and 5" Casters) 102STF14 No Charge
- 16.5" Seat to Floor (22" Wheels and 6" Casters) 102STF15 No Charge
- 17" Seat to Floor (22" Wheels and 7" Casters) 102STF16 No Charge
- 17" Seat to Floor (24" Wheels and 6" Casters) 102STF17 No Charge
- 17.5" Seat to Floor (24" Wheels and 6" Casters) 102STF18 No Charge
- 17.5" Seat to Floor (24" Wheels and 7" Casters) 102STF19 No Charge
- 18" Seat to Floor (24" Wheels and 6" Casters) 102STF20 No Charge
- 18" Seat to Floor (24" Wheels and 7" Casters) 102STF21 No Charge
- 18.5" Seat to Floor (24" Wheels and 7" Casters) 102STF22 No Charge
- 18.5" Seat to Floor (24" Wheels and 8" Casters) 102STF23 No Charge
- 19" Seat to Floor (24" Wheels and 8" Casters) 102STF24 No Charge

⑧ REAR WHEEL RIM

- Mag Wheels----- 102RW09 No Charge
- Spoke Wheels----- 102RW10 \$75

⑨ REAR WHEEL TIRE

- Airless (Solid Rubber) ----- 102RT1 Standard
- Pneumatic ----- 102RT2 No Charge

⑩ HANDRIM OPTIONS

- Chrome ----- 102HR1 Standard
- Plastic Coated----- 102HR2 \$110
- Omit Handrims----- 102HR3 less net \$15

⑪ ARM TYPE

- Flip Back Adjustable Height ----- 102AR09 \$275
- Flip Back Fixed Height ----- 102AR10 \$225

12 ARM PAD

- Contour Gel 17" (pair) ----- 102AP3 Standard
- Desk length Vinyl 10" (pair) ----- 102AP1 No Charge
- Full length Vinyl 14" (pair) ----- 102AP2 No Charge

13 BACK TYPE

- ^D Angle Adj 10 deg Bend w/Push Handle (low)----- 102PC3 Standard
- ^D Angle Adj 10 deg Bend w/Push Handle (high)----- 102PC4 \$90

14 BACK UPHOLSTERY

- Slip-on Padded Back Upholstery----- 102BK48 Standard
- Adjustable Tension Back----- 102BK45 \$150
- Prism Basic Back on chair Stock ----- 102BK01 \$500
- Prism Basic Back on chair Non Stock ----- 102BK02 \$525
- Prism Basic Back on chair Custom----- 102BK04 \$825
- Prism Ultra Back on chair Stock ----- 102BK06 \$600
- Prism Ultra Back on chair Non Stock ----- 102BK07 \$625
- Prism Ultra Back on chair Custom ----- 102BK09 \$1,010
- Prism Air Back on chair Stock ----- 102BK11 \$650
- Prism Air Back on chair Non Stock ----- 102BK12 \$675
- Prism Air Back on chair Custom ----- 102BK14 \$1,075
- Prism TrueFitt Back on chair Stock ----- 102BK16 \$750
- Prism TrueFitt Back on chair Non Stock ----- 102BK17 \$775
- Prism TrueFitt Back on chair Custom----- 102BK19 \$1,025
- Prism Max Ultra Back on chair Stock----- 102BK21 \$650
- Prism Max Ultra Back on chair Non Stock----- 102BK22 \$675
- Prism Max Ultra Back on chair Custom----- 102BK24 \$1,060
- Prism Max Air Back on chair Stock----- 102BK26 \$700
- Prism Max Air Back on chair Non Stock----- 102BK27 \$725
- Prism Max Air Back on chair Custom----- 102BK29 \$1,125
- Prism Max TrueFitt Back on chair Stock----- 102BK31 \$800
- Prism Max TrueFitt Back on chair Non Stock----- 102BK32 \$825
- Prism Max TrueFitt Back on chair Custom----- 102BK34 \$1,075
- Lunar Back Low No Lateral on chair ----- 102BK36 \$500
- Lunar Back Low Basic Lateral on chair----- 102BK37 \$575
- Lunar Back Mid No Lateral on chair ----- 102BK38 \$590
- Lunar Back Mid Basic Lateral on chair----- 102BK39 \$650
- Lunar Back Mid Ultra Lateral on chair----- 102BK40 \$710
- Lunar Back Full No Lateral on chair ----- 102BK41 \$610
- Lunar Back Full Basic Lateral on chair----- 102BK42 \$670
- Lunar Back Full Ultra Lateral on chair----- 102BK43 \$730
- Lunar Back Custom on chair----- 102BK44 \$1,050
- Omit Back Upholstery----- 102BK49 less net \$20
- Specify Back Size W ____ x H ____

FOOTNOTES:

D. Back angle adjusts -7 degrees to 21 degrees
in 7 degree increments

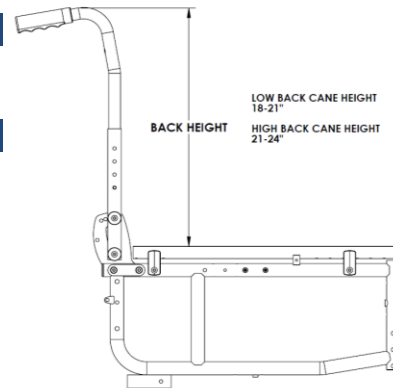

15 BACK PINS (Prism Backs only)

- Longer Pins for Back Hardware 1" Growth ----- 102BP1 \$50
- Longer Pins for Back Hardware 2" Growth ----- 102BP2 \$50

16 SEAT OPTIONS

<input type="checkbox"/> Black Nylon Seat Upholstery-----	102SC19	Standard
<input type="checkbox"/> Omit Seat Upholstery-----	102SC20	less net \$20
<input type="checkbox"/> Prism Ideal Cushion Stock Sizes-----	102SC01	\$175
<input type="checkbox"/> Prism Ideal Cushion Non-Stock Sizes-----	102SC02	\$200
<input type="checkbox"/> Prism Ideal Cushion Custom Sizes-----	102SC03	\$275
<input type="checkbox"/> Prism Elite Cushion Stock Sizes-----	102SC04	\$250
<input type="checkbox"/> Prism Elite Cushion Non-Stock Sizes-----	102SC05	\$275
<input type="checkbox"/> Prism Elite Cushion Custom Sizes-----	102SC06	\$425
<input type="checkbox"/> Prism Supreme Cushion Stock Sizes-----	102SC07	\$375
<input type="checkbox"/> Prism Supreme Cushion Non-Stock Sizes-----	102SC08	\$400
<input type="checkbox"/> Prism Supreme Cushion Custom Sizes-----	102SC09	\$685
<input type="checkbox"/> Prism Supreme II Plus Cushion Stock Sizes-----	102SC10	\$375
<input type="checkbox"/> Prism Supreme II Plus Cushion Non-Stock Sizes-----	102SC11	\$400
<input type="checkbox"/> Prism Supreme II Plus Cushion Custom Sizes-----	102SC12	\$685
<input type="checkbox"/> Prism Supreme Air Cushion Stock Sizes-----	102SC13	\$500
<input type="checkbox"/> Prism Supreme Air Cushion Non-Stock Sizes-----	102SC14	\$575
<input type="checkbox"/> Prism Supreme Air Cushion Custom Sizes-----	102SC15	\$785
<input type="checkbox"/> Prism Supreme Drop Base Flush Mount Stock Sizes-----	102SC21	\$755
<input type="checkbox"/> Prism Supreme Drop Base 1" Stock Sizes-----	102SC22	\$755
<input type="checkbox"/> Prism Supreme Drop Base 2" Stock Sizes-----	102SC23	\$755
<input type="checkbox"/> Prism Supreme Drop Base Flush Mount Non Stock-----	102SC24	\$810
<input type="checkbox"/> Prism Supreme Drop Base 1" Non Stock-----	102SC25	\$810
<input type="checkbox"/> Prism Supreme Drop Base 2" Non Stock-----	102SC26	\$810
<input type="checkbox"/> Prism Supreme Drop Base Flush Mount Custom Sizes-----	102SC27	\$935
<input type="checkbox"/> Prism Supreme Drop Base 1" Custom Sizes-----	102SC28	\$935
<input type="checkbox"/> Prism Supreme Drop Base 2" Custom Sizes-----	102SC29	\$935
<input type="checkbox"/> Prism Drop Base Flush Mount Stock Sizes-----	102SC30	\$180
<input type="checkbox"/> Prism Drop Base 1" Stock Sizes-----	102SC31	\$180
<input type="checkbox"/> Prism Drop Base 2" Stock Sizes-----	102SC32	\$180
<input type="checkbox"/> Prism Drop Base Flush Mount Non Stock Sizes-----	102SC33	\$210
<input type="checkbox"/> Prism Drop Base 1" Non Stock Sizes-----	102SC34	\$210
<input type="checkbox"/> Prism Drop Base 2" Non Stock Sizes-----	102SC35	\$210
<input type="checkbox"/> Prism Drop Base Flush Mount Custom Sizes-----	102SC36	\$250
<input type="checkbox"/> Prism Drop Base 1" Custom Sizes-----	102SC37	\$250
<input type="checkbox"/> Prism Drop Base 2" Custom Sizes-----	102SC38	\$250

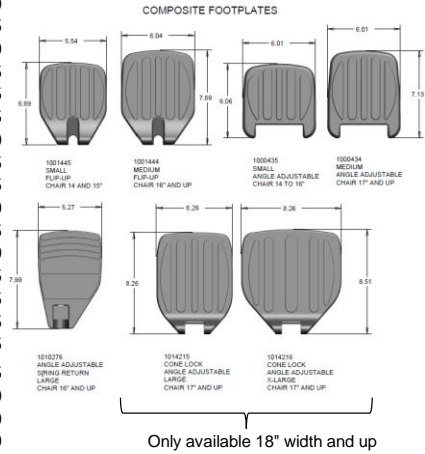

ALUMINUM FOOTPLATES

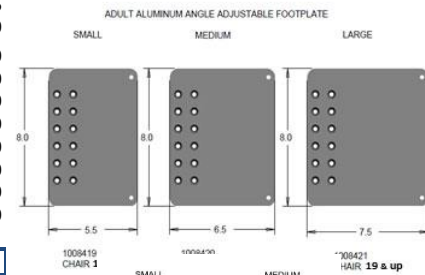

Only available 18" width and up

17 FRONT RIGGING

<input type="checkbox"/> 70 Degree Swingaway Pinstyle-----	102FR01	\$132
<input type="checkbox"/> 80 Degree Swingaway Pinstyle-----	102FR02	\$135
<input type="checkbox"/> 60 Degree Swingaway Upgraded-----	102FR03	No Charge
<input type="checkbox"/> 70 Degree Swingaway Upgraded-----	102FR04	No Charge
E, F <input type="checkbox"/> 90 Degree Swingaway Upgraded-----	102FR05	\$230
<input type="checkbox"/> Elevating Legrest (pair) -----	102FR10	\$550

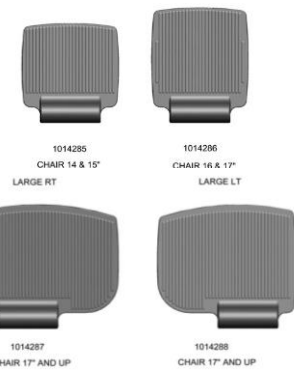

18 FOOTPLATE TYPE

<input type="checkbox"/> Composite Flip-Up Footplates Small -----	102FP01	No Charge
<input type="checkbox"/> Composite Flip-Up Footplates Large -----	102FP02	No Charge
<input type="checkbox"/> Aluminum Flip-Up Footplates Small -----	102FP05	Standard
<input type="checkbox"/> Aluminum Flip-Up Footplates Medium -----	102FP06	Standard
<input type="checkbox"/> Aluminum Flip-Up Footplates Large -----	102FP07	Standard
<input type="checkbox"/> Composite Angle Adj Flip-Up Footplates Medium (18" up)-----	102FP09	\$120
<input type="checkbox"/> Composite Angle Adj. Flip-Up Cone Lock Large-----	102FP16	\$150
<input type="checkbox"/> Composite Angle Adj. Flip-Up Cone Lock X-Large-----	102FP17	\$170
<input type="checkbox"/> Aluminum Angle Adj Flip-Up Footplates Small-----	102FP10	\$120
<input type="checkbox"/> Aluminum Angle Adj Flip-Up Footplates Medium -----	102FP11	\$120
<input type="checkbox"/> Aluminum Angle Adj Flip-Up Footplates Large -----	102FP12	\$120
<input type="checkbox"/> Composite Adjustable Angle Flip-Up Footplates Spring Return--	102FP04	\$150
G <input type="checkbox"/> One Piece Flip-Up Footboard -----	102FP19	\$160

19 FOOTREST/LEGREST ACCESSORIES

<input type="checkbox"/> Padded Calf Strap-----	102FA03	\$70
<input type="checkbox"/> Foam Guards on Elevating Legrest (pair)-----	102FA05	\$70
<input type="checkbox"/> Foam Pad on Footplate (pair)-----	102FA07	\$70
<input type="checkbox"/> Foam Pad on One Piece Footboard-----	102FA06	\$50
<input type="checkbox"/> Heel Loops-----	102FA01	Standard
<input type="checkbox"/> Omit Heel Loops-----	102FA02	less net \$7

20 WHEEL LOCKS

<input type="checkbox"/> Push-to-Lock Wheel Lock-----	102WL1	Standard
<input type="checkbox"/> Pull-to-Lock Wheel Lock-----	102WL2	No Charge
<input type="checkbox"/> Wheel Lock Extension-----	102WL3	No Charge

FOOTNOTES:

- E. Not available with composite footplate with 6", 7" or 8" casters.
- F. Not available with angle adjustable footplate with 6", 7" or 8" casters.
- G. Not available with 6", 7" or 8" caster footboard is facing back on 90 degree Swingaway.

ANTI TIP

- Fixed Anti-Tippers 102MA22 No Charge

MISCELLANEOUS ACCESSORIES

- Auto-Seat Positioning Straps..... 102MA03 \$52
- Velcro Release Positioning Strap..... 102MA05 \$48
- Quick Release Axles..... 102AL1 \$110
- Foam Pad on Arm Guard (pair)..... 102MA06 \$140
- Padded Lap Tray 15"-16"..... 102MA09 \$285
- Padded Lap Tray 17"-18"..... 102MA10 \$285
- Padded Lap Tray 19"-20"..... 102MA11 \$285
- Half Padded Lap Tray, left side..... 102MA14 \$160
- Half Padded Lap Tray, right side..... 102MA15 \$160
- IV Pole, telescopic..... 102MA20 \$168
- Oxygen Tank Holder..... 102MA21 \$175
- Spoke Guards available on 20", 22" and 24" wheels..... 102MA49 \$130

MOUNT POSITION # 2

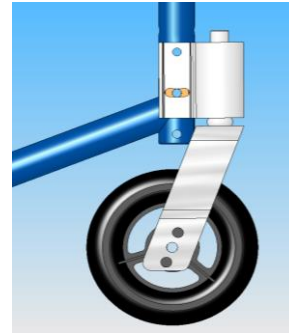

X-SMALL FORK



SHORT FORK

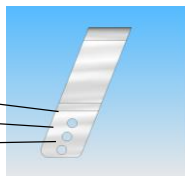

LONG FORK

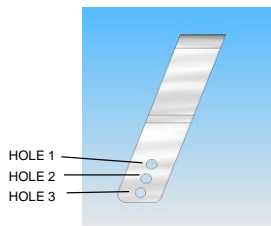

MOUNT POSITION # 1

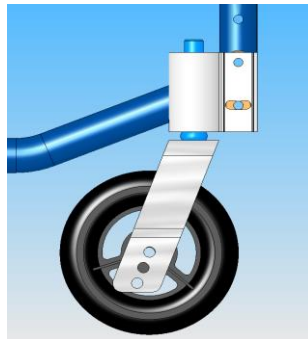

REAR MOUNT PLATE

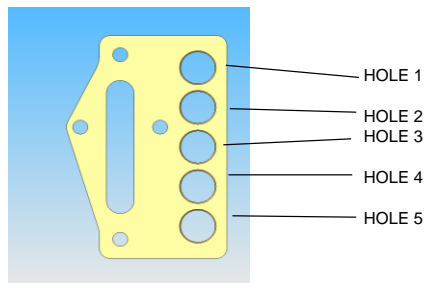

WARRANTY

Future Mobility Healthcare warrants the STELLATO wheelchair to be free from defects in materials and workmanship for a period of two (2) year from the date of purchase. The side frame is warranted for the lifetime of the original purchaser and/or user.